

### Outline:

- Bifilar Winding, high coupling factor.
- Magnetic shielded structure, excellent resistance to electro magnetic interference(EMI).
- Can be used in series or parallel, suitable for SEPIC, Zeta and other circuit topologies.

### Features:

- Core material: Ferrite.
- Environmental: RoHS compliant, halogen free.
- Weight: 10.45g
- Moisture Sensitivity: Level (MSL) 1 (unlimited floor life at <math><30^{\circ}\text{C}</math> /85% relative humidity).
- Operating temperature range: - Storage temperature range:

### Application:

- For SEPIC and CUK topologies.
- Flyback applications.
- Switching regulators with second, unregulated output voltage.

## 1 Electrical Characteristics

Part No.	Inductance	Lk	D.C.R. (m $\Omega$ )		Isat	I <sub>rms</sub>	HI-POT
	( $\mu\text{H}$ ) ※1	( $\mu\text{H}$ ) ※2	Typ.	Max.	(A) ※4	(A) ※5	(Vdc) ※6
CRHCM1514-100M:100M	10.0 $\pm$ 20%	0.37	26.6	31.9	15.10	8.20	500
CRHCM1514-120M:120M	12.0 $\pm$ 20%	0.30	27.5	33.0	13.50	7.90	500
CRHCM1514-150M:150M	15.0 $\pm$ 20%	0.27	30.3	36.4	12.50	7.50	500
CRHCM1514-220M:220M	22.0 $\pm$ 20%	0.46	35.5	42.6	10.40	6.90	500
CRHCM1514-270M:270M	27.0 $\pm$ 20%	0.51	40.1	48.1	9.65	6.40	500
CRHCM1514-330M:330M	33.0 $\pm$ 20%	0.24	45.0	54.0	8.30	5.90	500
CRHCM1514-470M:470M	47.0 $\pm$ 20%	0.60	55.0	66.0	7.10	5.60	500
CRHCM1514-680M:680M	68.0 $\pm$ 20%	0.54	68.2	81.8	6.00	5.05	500
CRHCM1514-101L:101L	100.0 $\pm$ 15%	0.50	99.7	120	5.00	4.10	500

## 2 Product Dimensions (mm)

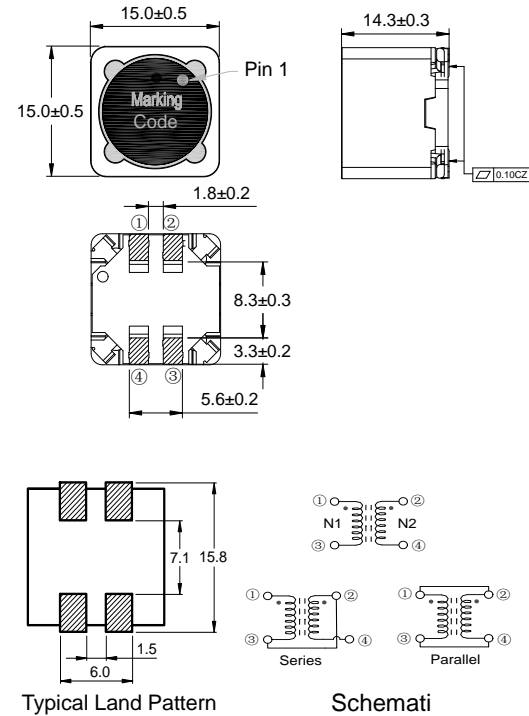

### All data is tested on 25°C ambient temperature

- ※1 Inductance: Inductance measure condition at 100kHz, 0.1V. When leads are connected in parallel, inductance is same as the value. When leads are connected in series, inductance is four times of the value.
- ※2 Leakage inductance is for N1 and is measured with N2 shorted.
- ※3 D.C.R.: When leads are connected in parallel, DCR is half of the value. When leads are connected in series, DCR is twice of the value.
- ※4 Saturation current: the actual value of DC current when the inductance decrease 10% and 30% of its initial value. When leads are connected in parallel, Saturation current is the same. When leads are connected in series, Saturation current is half of the value.
- ※5 Temperature rise current(I<sub>r</sub>): The leads are connected in parallel, the actual value of DC current when the temperature rise is  $\Delta T40^{\circ}\text{C}$ . When leads are connected in series, temperature rise current is half of the value I<sub>r</sub>.
- ※6 HI-POT: Test the withstand voltage of two windings
- ※ Special remind: Circuit design, component placement, PCB size and thickness, cooling system and etc. all will affect the product temperature. Please verify the product temperature in the final application.

**3 Saturation Current vs Temperature Rise Current Curve**

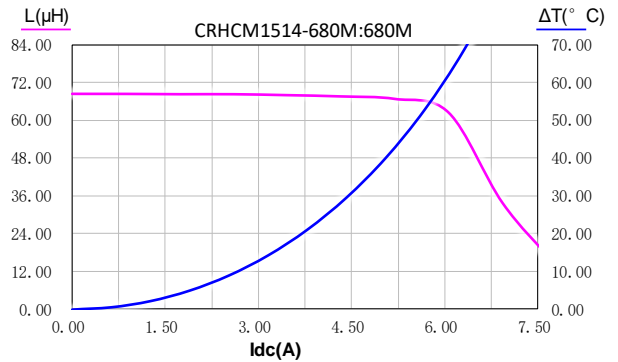
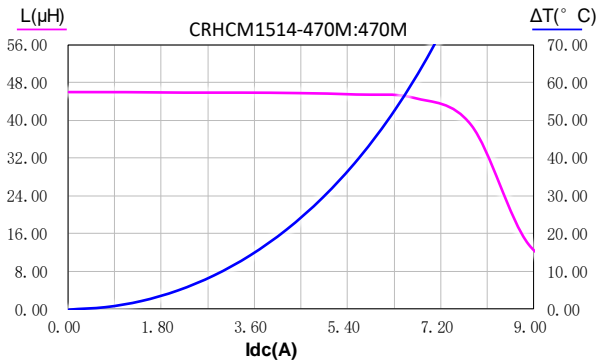
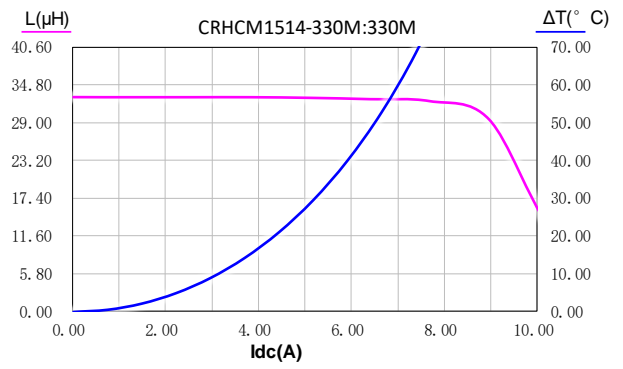
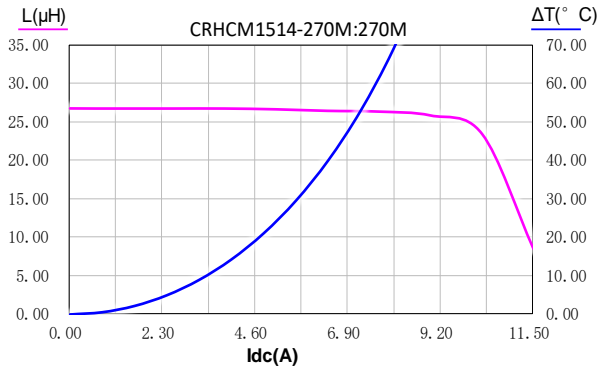
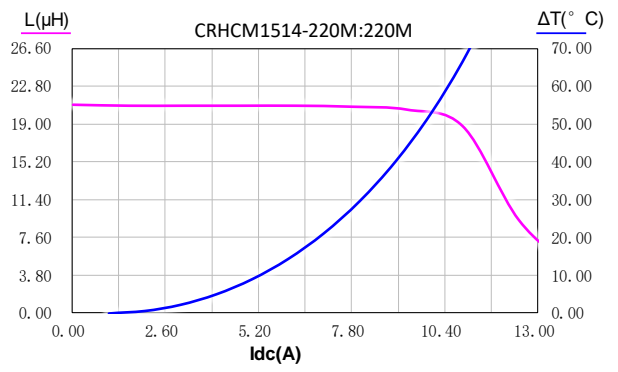
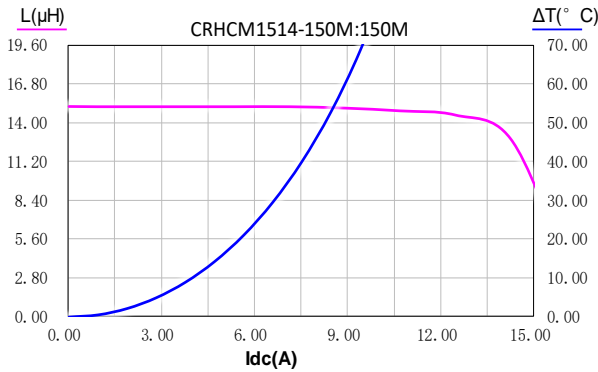
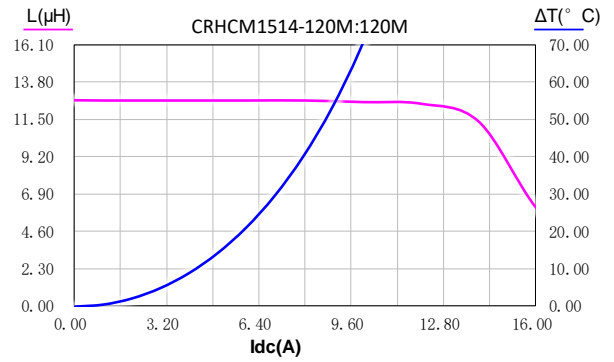
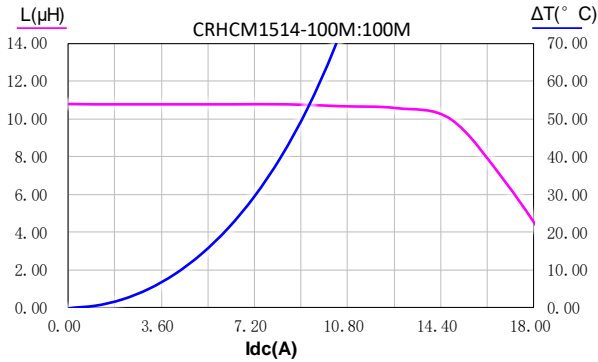

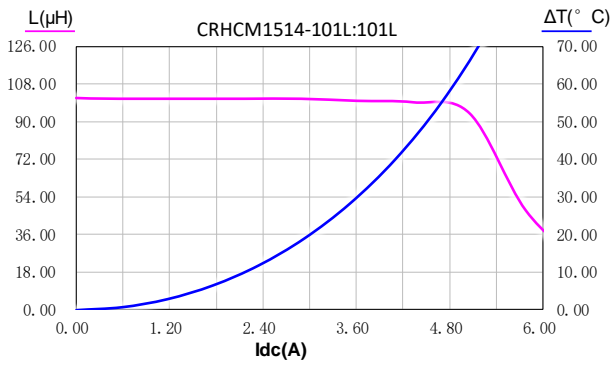

**4 L vs Frequency Curve**

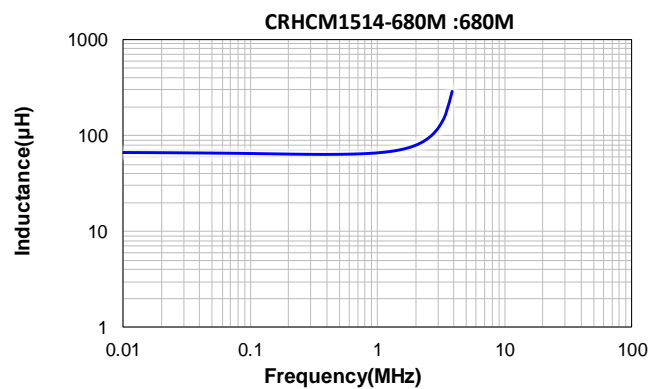
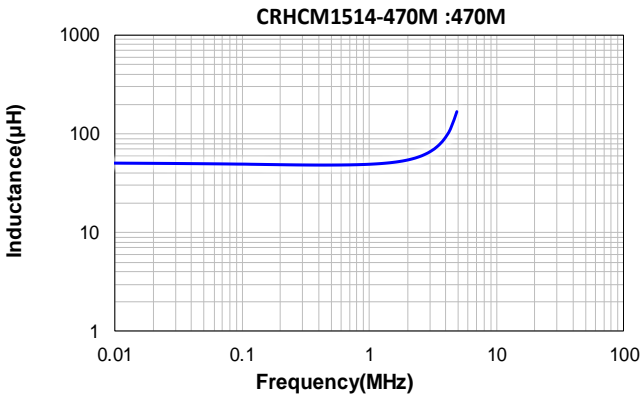
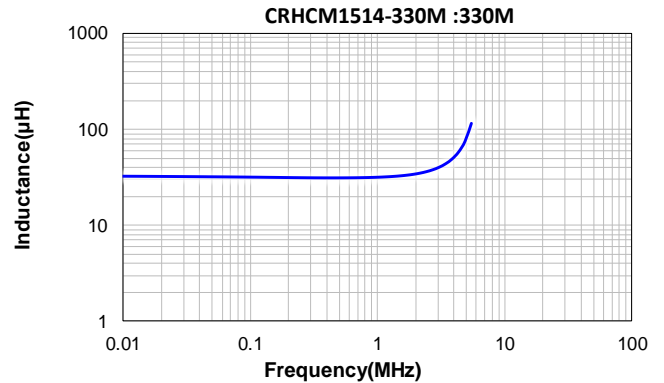
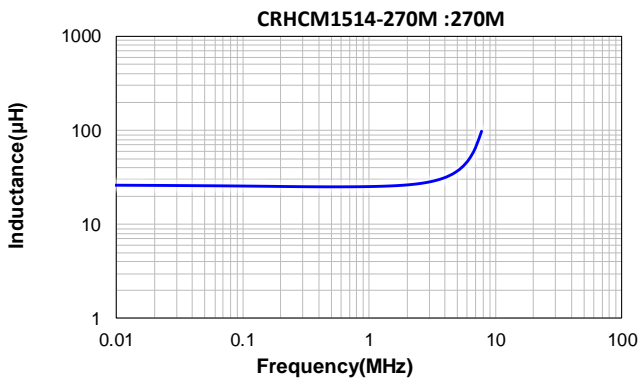
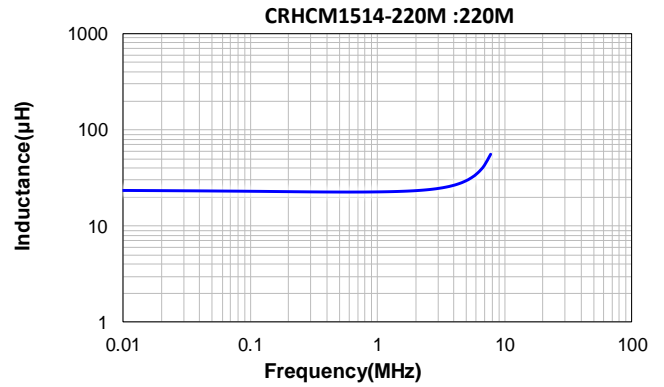
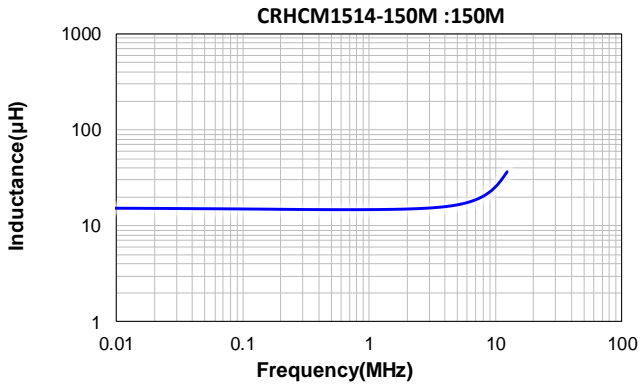
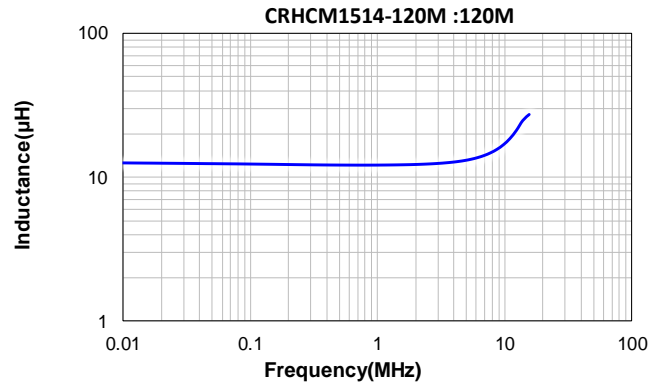
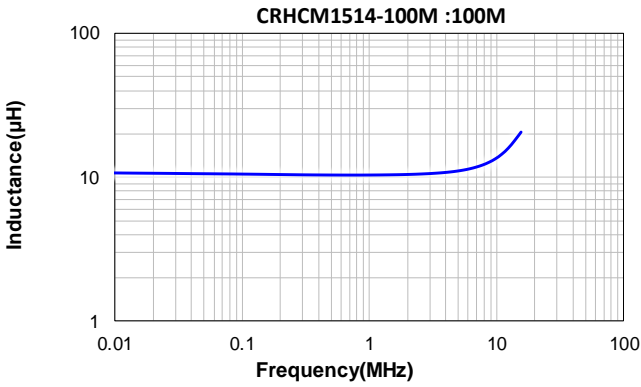

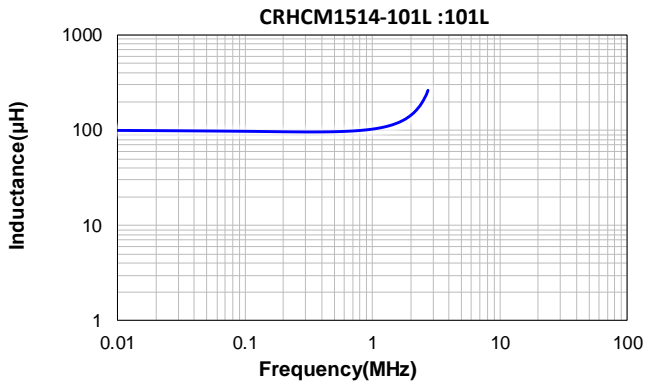

**5 Impedance vs Frequency Curve**

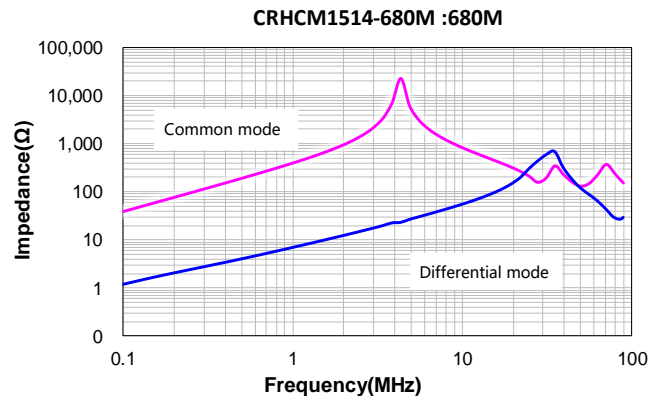
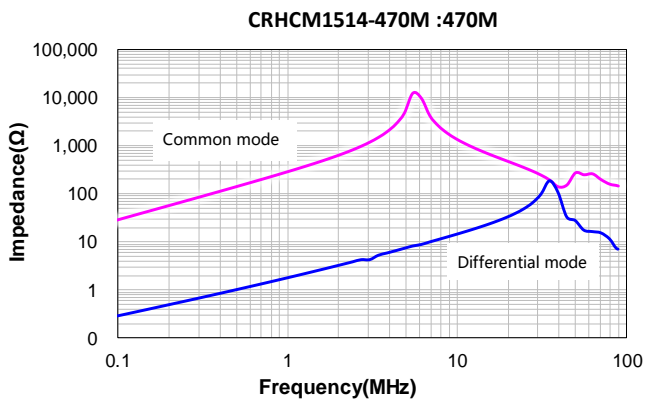
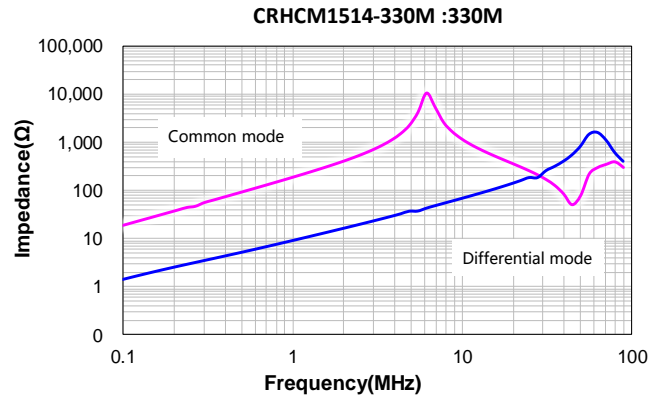
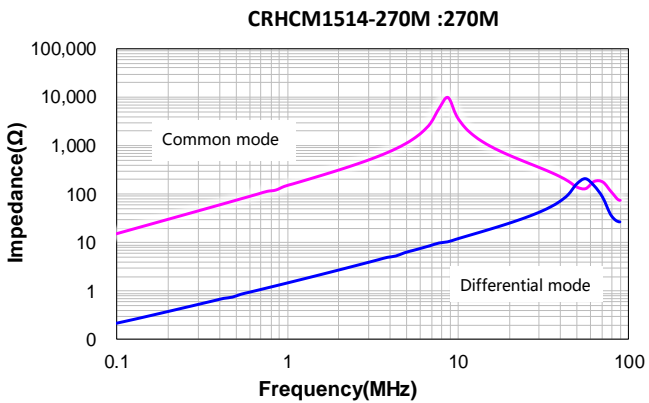
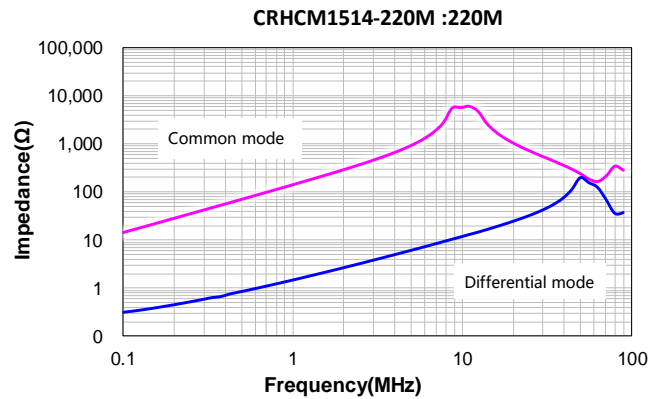
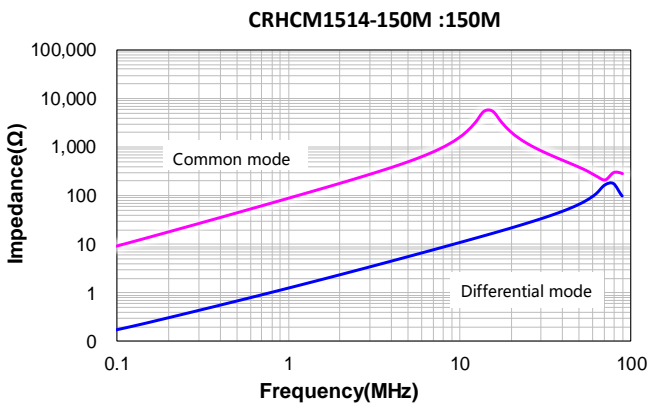
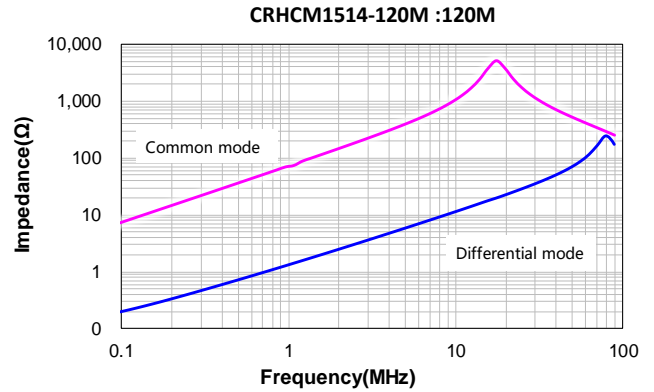
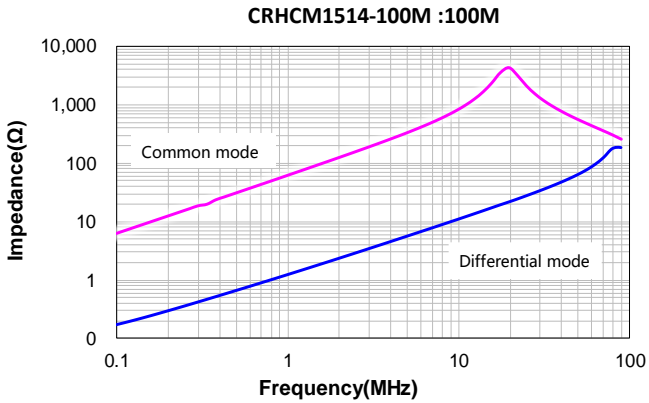

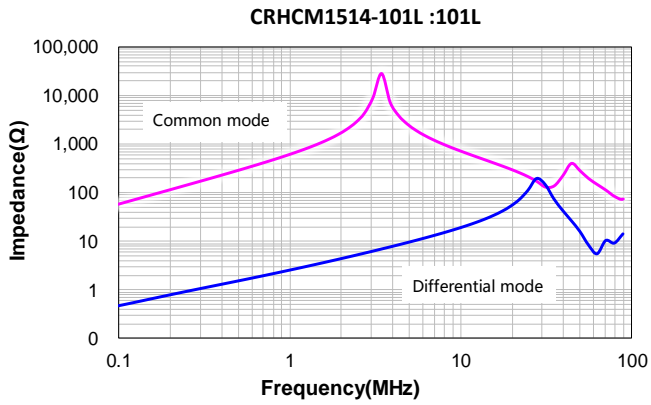

## 6 Packing Specification

### 6.1 Carrier Tape Dimensions (mm)

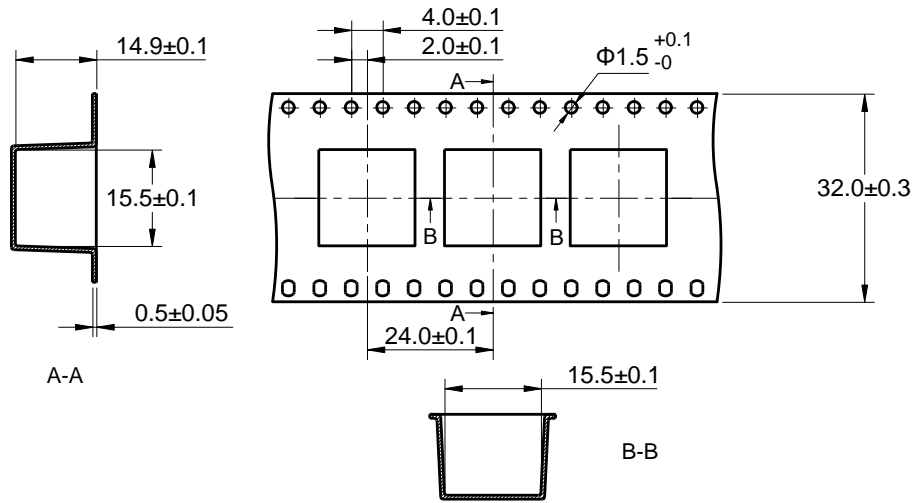

※ Packing is referred to the international standard IEC 60286-3.

### 6.2 Reel Dimensions (mm)

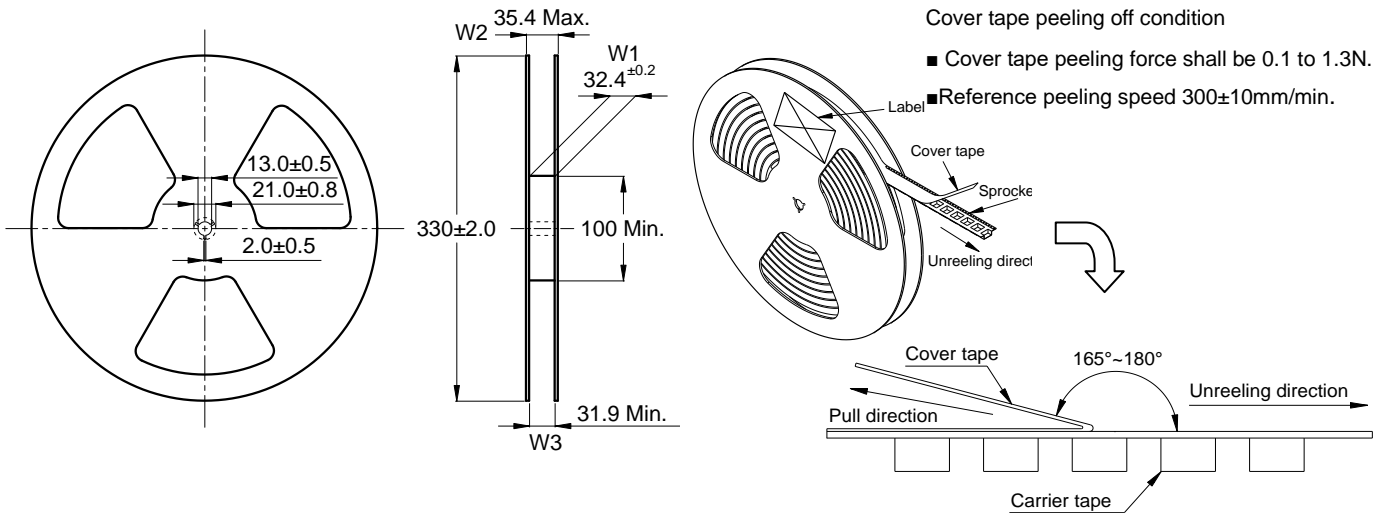

Cover tape peeling off condition

- Cover tape peeling force shall be 0.1 to 1.3N.
- Reference peeling speed 300±10mm/min.

### 6.3 Carton Dimensions and Packing Quantity

■ Inner Carton: 340×340×95mm

■ Out Carton : 360×360×370mm

Product Series	Quantity / Reel	Inner Carton Quantity	Out Carton Quantity
CRHCM1514-Series	150pcs	(150×2) = 300pcs	(300×3) = 900pcs

**7 Soldering Specification**

7.1 Reflow Profile for SMT Components

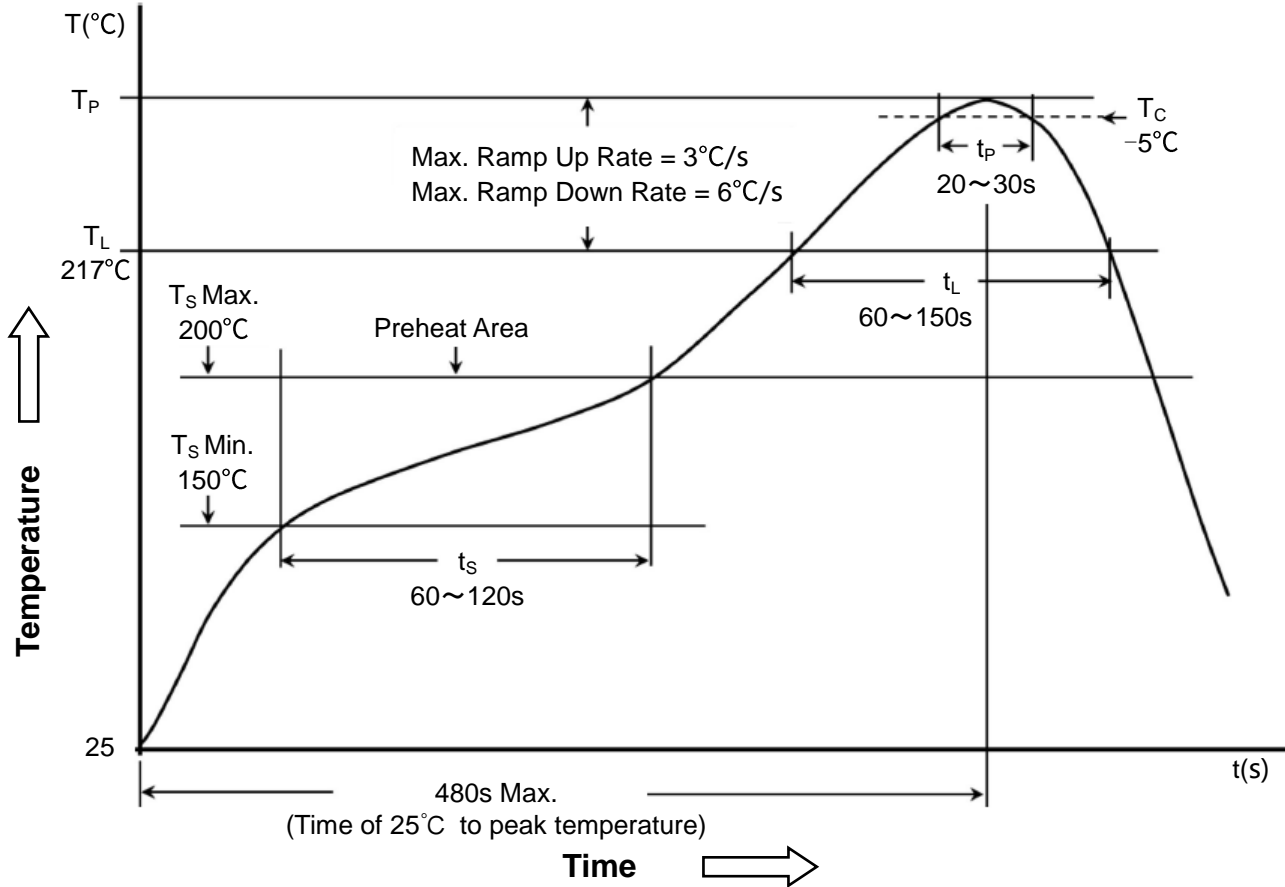

7.2 Classification of Peak Package Body Temperature (Tp)

	Package Thickness	Package Volume		
		<350 mm <sup>3</sup>	350~2000 mm <sup>3</sup>	>2000 mm <sup>3</sup>
PB-Free Assembly	<1.6mm	260°C	260°C	260°C
	1.6~2.5mm	260°C	250°C	245°C
	≥2.5mm	250°C	245°C	245°C

※ Reflow is referred to standard IPC/JEDEC J-STD-020E.

**8 Notice of use**

- 8.1 Product in packing storage condition : temperature 5~40°C, RH≤70%.  
If taking out for use, the remaining products should be sealed in plastic bags and preserved in accordance with the above conditions, to avoid oxidation of terminals (electrodes), affecting soldering status.
- 8.2 A storage of Codaca Electronic products for longer than 12 months is not recommended, Within other effects, the terminals may suffer degradation, resulting in bad solderability. Therefore, all products shall be used within the period of 12 months based on the day of shipment.
- 8.3 Do not keep products in unsuitable storage conditions, such as areas susceptible to high temperatures, high humidity, dust or corrosion.
- 8.4 Always handle products with care.
- 8.5 Don't touch electrodes directly with bare hands as oil secretions may inhibit soldering.  
Always ensure optimum conditions for soldering.
- 8.6 When this product will be used on a similar or new project to the original one, sometimes it might be unable to satisfy the specifications due to different condition of usage.
- 8.7 This inductor itself does not have any protective function in abnormal condition, such as overload, short-circuit, open-circuit conditions, etc. Therefore, it shall be confirmed that there is no risk of smoke, fire, dielectric withstand voltage, insulation resistance, etc., or use in abnormal conditions protective devices or protection circuit in the end product.
- 8.8 Hi-Pot test with higher voltage than spec value will damage insulating material and shorten its life.
- 8.9 If using in potting compound, the magnet wire coating might be damaged, please consult with us.
- 8.10 Refrain from rinsing product. If necessary, please consult with us.
- \*8.11 Codaca Electronic products without "V" prefix are qualified for industrial product requirement , and with "V" prefix are qualified for AEC-Q200, but it doesn't mean that Codaca Electronic products can absolutely meet specific industry norms and quality test standards in automotive electronics or more strict application fields . Codaca Electronic will be exempted from being responsible for the consequences of using Codaca products in automotive electronic or higher application field related to safety when without being aware of it.