

### Outline:

- High frequency low loss magnetic core material
- Low cost, high reliability
- For high frequency noise suppression

### Features:

- Core material: Ferrite
- Environmental: RoHS, Reach compliant, Halogen free
- Weight: RID236453-800 (0.55g)  
RID237555-101 (0.70g)  
RID237575-111 (0.80g)
- Moisture Sensitivity: Level (MSL) 1  
(unlimited floor life at <math><30^{\circ}\text{C}</math> / 85% relative humidity)
- Operating temperature range:   
(including coil's self temperature rise)
- Storage temperature range:

### Application:

- Widely used in VGA card, EGA card, mother board, TV game

## 1 Product Dimensions (mm)

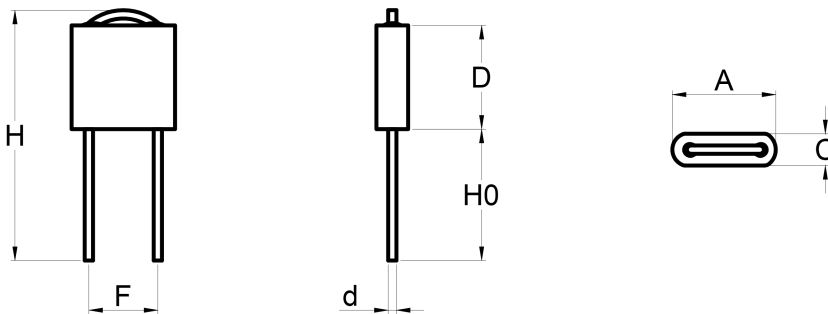

Part No.	A ( mm )	C ( mm )	D ( mm )	d ( mm )	F ( mm )	H ( mm )	H0 ( mm )	E ( mm )
RID236453-800	6.40±0.30	2.30±0.30	5.30±0.30	0.60±0.05	2.50±0.5	32.5Max.	18.5±1.00	1.0Ref.
RID237555-101	7.50±0.30	2.30±0.30	5.50±0.30	0.60±0.05	5.00±0.5	32.5Max.	18.5±1.00	1.0Ref.
RID237575-111	7.50±0.30	2.30±0.30	7.50±0.30	0.60±0.05	5.00±0.5	32.5Max.	18.5±1.00	1.0Ref.

## 2 Reference Hole Pattern (mm)

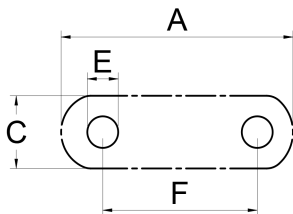

## 3 Schematic

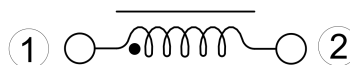

## 4 Electrical Characteristics

Part No.	Impedance( $\Omega$ ) ※1		D.C.R. (m $\Omega$ )	Rated Current (A) ※2	Hi-pot (Vdc)	Insulation Resistance (M $\Omega$ )
	Min.	Max.	Max.	Max.	2mA 3S	Min.
RID236453-800	50.0	80.0	10.0	7.00	500	100
RID237555-101	65.0	100	10.0	7.00	500	100
RID237575-111	80.0	110	10.0	7.00	500	100

All data is tested on 25°C ambient temperature

※1 Impedance measure condition at 25MHz,0.05V,100MHz,0.05V.

※2 Rated current : the actual value of DC current when the temperature rise is  $\Delta T40^{\circ}\text{C}$ ( $T_a=25^{\circ}\text{C}$ ).

**5 Impedance vs Frequency Curve**

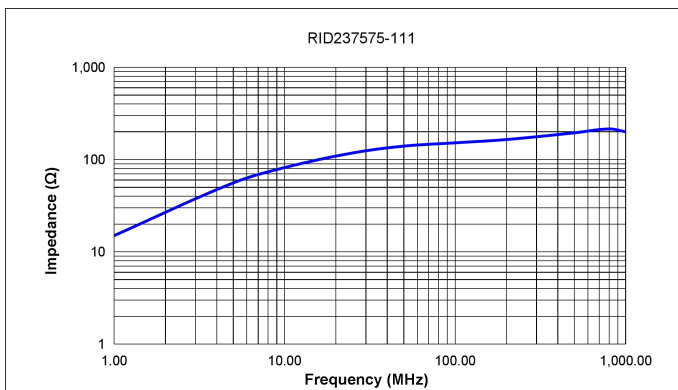
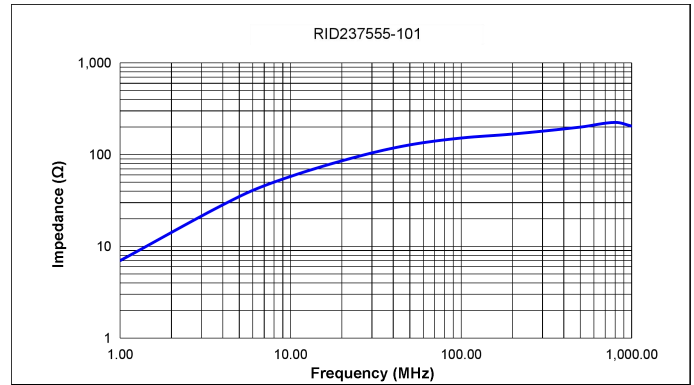
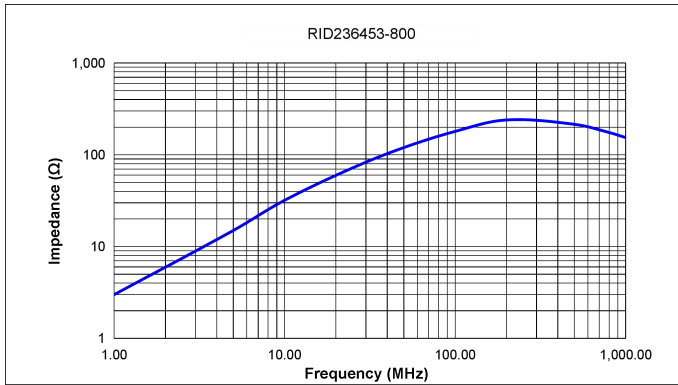

**6 Packing Specification**

6.1 Taping dimensions (mm)

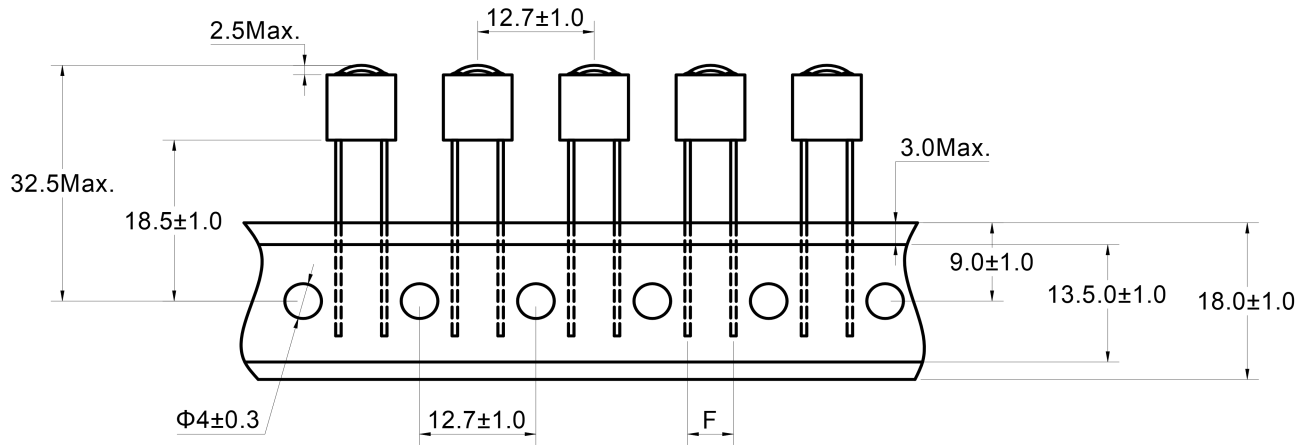

6.2 Packing(mm)

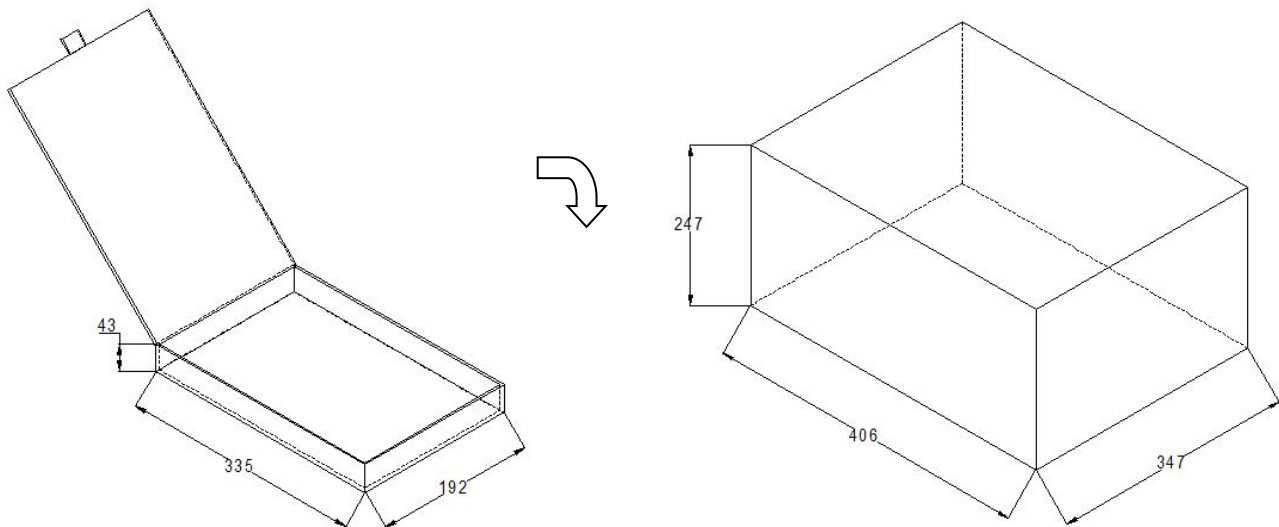

Part No.	Quantity / Carton	No. of Inner Carton	Packaging Unit	Material
RID236453-800	2000 Pcs	10 Pcs	20000 Pcs	Paper
RID237555-101	2000 Pcs	10 Pcs	20000 Pcs	Paper
RID237575-111	2000 Pcs	10 Pcs	20000 Pcs	Paper

**7 Soldering Specification**

7.1 Wave soldering temperature curve

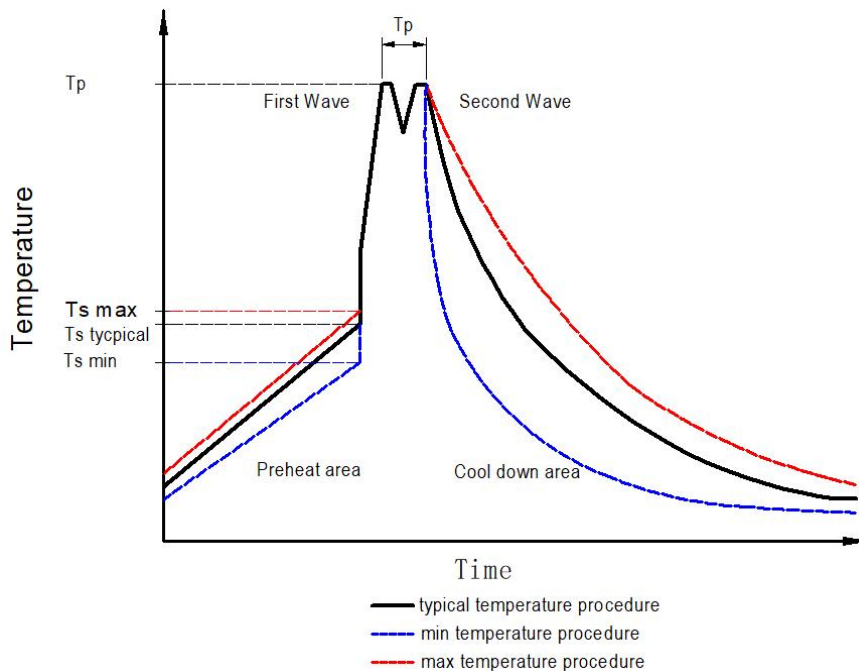

7.2 Classification Wave Soldering Profile:

Profile Feature		Pb-Free Assembly	Sn-Pb Assembly
Preheat Temperature Min	$T_s \text{ min}$	100 °C	100 °C
Preheat Temperature Typical	$T_s \text{ typical}$	120 °C	120 °C
Preheat Temperature Max	$T_s \text{ max}$	130 °C	130 °C
Preheat Time $t_s$ from $T_s \text{ min}$ to $T_s \text{ max}$	$t_s$	70 seconds	70 seconds
Ramp-up Rate	$\Delta T$	150 °C max.	150 °C max.
Peak Temperature	$T_p$	250 °C - 260 °C	235 °C - 260 °C
Time of actual peak temperature	$t_p$	max. 10 seconds max. 5 seconds each wave	max. 10 seconds max. 5 seconds each wave
Ramp-down Rate, Min		~ 2 K/ second	~ 2 K/ second
Ramp-down Rate, Typical		~ 3.5 K/ second	~ 3.5 K/ second
Ramp-down Rate, Max		~ 5 K/ second	~ 5 K/ second
Time 25 °C to 25 °C		4 minutes	4 minutes

※ Wave Soldering is refer to standard EN61760-1:2006.

## 8 Notice of Use

- 8.1 Special remind: Circuit design, component placement, PCB size and thickness, cooling system and etc. all will affect the product temperature. Please verify the product temperature in the final application.
- 8.2 Product in packing storage condition: temperature 5 ~ 40°C, RH≤70%.  
If taking out for use, the remaining products should be sealed in plastic bags and preserved in accordance with the above conditions, to avoid oxidation of terminals (electrodes), affecting soldering status.
- 8.3 A storage of Codaca Electronic products for longer than 12 months is not recommended, Within other effects, the terminals may suffer degradation, resulting in bad solderability. Therefore, all products shall be used within the period of 12 months based on the day of shipment.
- 8.4 Do not keep products in unsuitable storage conditions, such as areas susceptible to high temperatures, high humidity, dust or corrosion.
- 8.5 Always handle products with care.
- 8.6 Don't touch electrodes directly with bare hands as oil secretions may inhibit soldering.  
Always ensure optimum conditions for soldering.
- 8.7 When this product will be used on a similar or new project to the original one,  
sometimes it might be unable to satisfy the specifications due to different condition of usage.
- 8.8 This inductor itself does not have any protective function in abnormal condition, such as overload, short-circuit, open-circuit conditions, etc. Therefore, it shall be confirmed that there is no risk of smoke, fire, dielectric withstand voltage, insulation resistance, etc., or use in abnormal conditions protective devices or protection circuit in the end product.
- 8.9 Hi-Pot test with higher voltage than spec value will damage insulating material and shorten its life.
- 8.10 If using in potting compound, the magnet wire coating might be damaged, please consult with us.
- 8.11 Refrain from rinsing coils. If necessary, please consult with us.
- \* 8.12 Codaca Electronic products without "V" prefix are qualified for industrial product requirement, and with "V" prefix are qualified for AEC-Q200, but it doesn't mean that Codaca Electronic products can absolutely meet specific industry norms and quality test standards in automotive electronics or more strict application fields. Codaca Electronic will be exempted from being responsible for the consequences of using Codaca products in automotive electronic or higher application field related to safety when without being aware of it.