

### Outline:

- Small footprint power inductors designed for maximum efficiency And low cost
- Industry-standard pin spacings; protective PVC sleeve is available for extra demand
- In addition to the standard versions of inductors shown here custom inductors are available to meet your exact requirements

### Features:

- Core material: Ferrite
- Core and winding loss:
- Environmental: RoHS, Reach compliant ,Halogen free
- Weight: 3.966g
- Moisture Sensitivity: Level (MSL) 1 (unlimited floor life at <30°C / 85% relative humidity).
- Operating temperature range: -40°C ~ +125°C (including coil's self temperature rise)
- Storage temperature range: -40°C ~ +125°C

### Application:

- Ideal for noise filtering in power amplifiers, power supplies and Speaker crossover networks.
- buck converter, network communication equipment, and etc

## 1 Electrical Characteristics

Part No.	Inductance (μH)※1	D.C.R. (mΩ)		Isat (A)※2	Irms (A) ※3
		Typical	Max.		
PKS1014-101K	100±10%	101	121	3.20	2.65
PKS1014-151K	150±10%	151	181	2.52	2.00
PKS1014-181K	180±10%	181	221	2.30	1.65
PKS1014-221K	220±10%	227	272	2.10	1.60
PKS1014-471K	470±10%	434	521	1.38	1.15
PKS1014-561K	560±10%	565	678	1.28	0.95
PKS1014-681K	680±10%	696	835	1.20	0.90
PKS1014-102J	1,000±5%	971	1,165	0.96	0.80
PKS1014-122J	1,200±5%	1,070	1,284	0.90	0.70
PKS1014-152J	1,500±5%	1,397	1,676	0.72	0.68
PKS1014-222J	2,200±5%	2,105	2,526	0.67	0.48
PKS1014-332J	3,300±5%	3,138	3,766	0.43	0.40
PKS1014-822J	8,200±5%	6,976	8,371	0.36	0.30

## 2 Product Dimensions (mm)

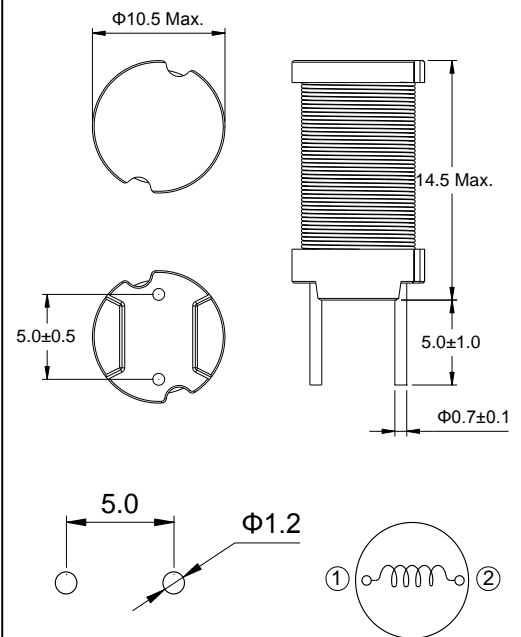

Typical Hole Pattern

Schematic

### All data is tested on 25°C ambient temperature

1. If the inductance is smaller than 1mH, can be measured at 100kHz, 0.1V, otherwise at 10kHz, 0.25V
2. Isat: the actual value of DC current when the Inductance decrease 20% of its initial value
3. Irms: the actual value of DC current when the the temperature rise is ΔT40°C (Ta=25°C)

### 3 Saturation Current vs Temperature Rise Current Curve

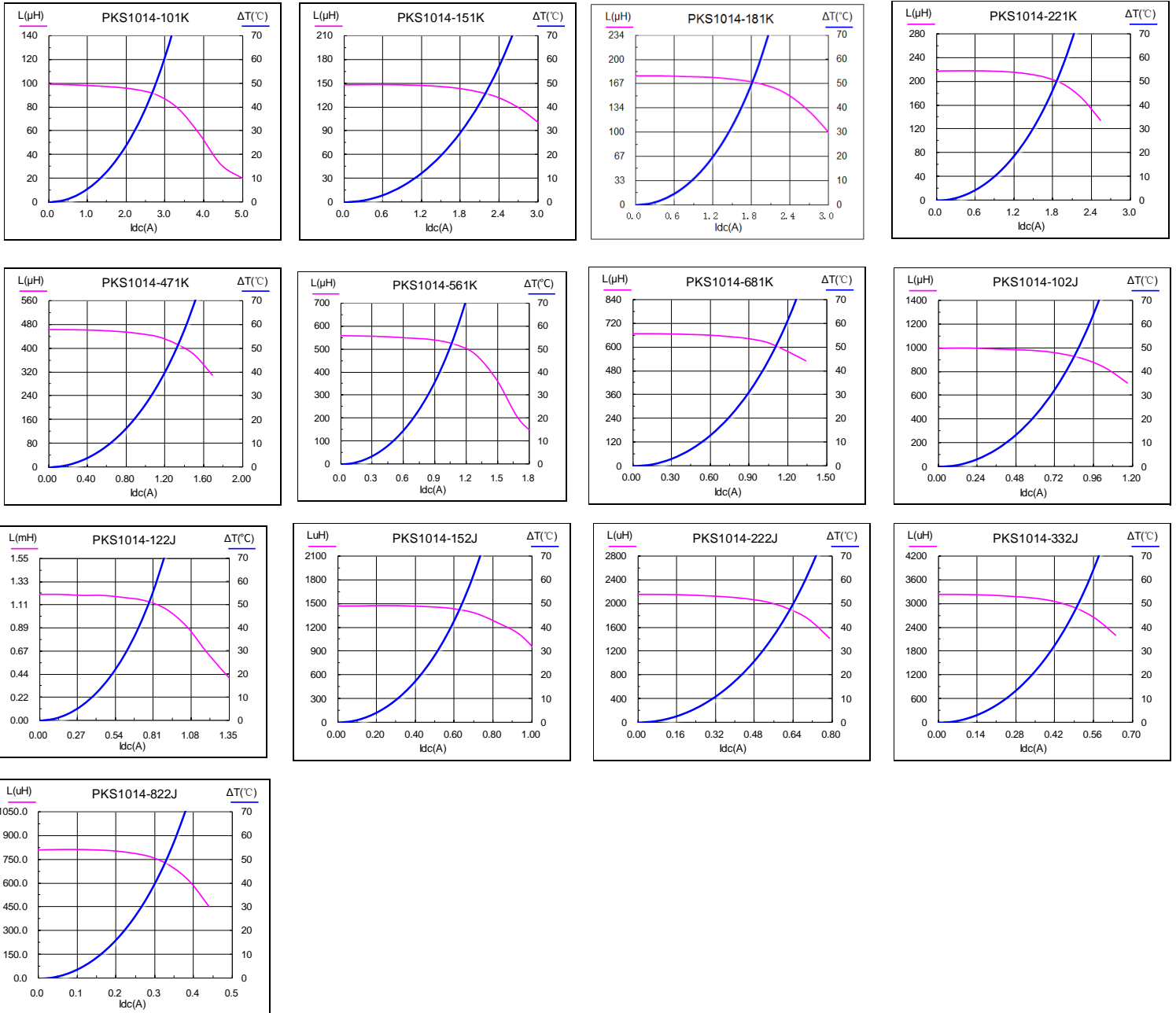

## 4 L vs Frequency

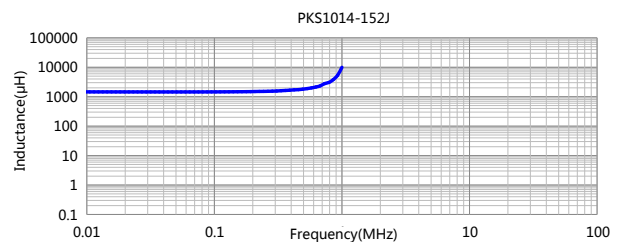
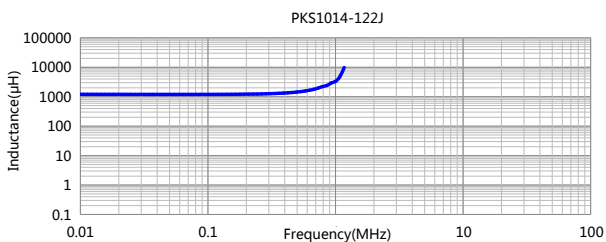
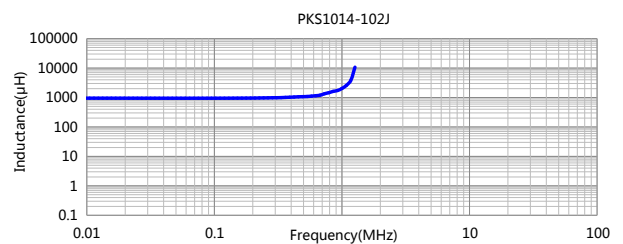
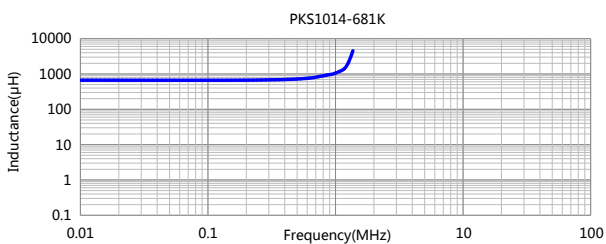
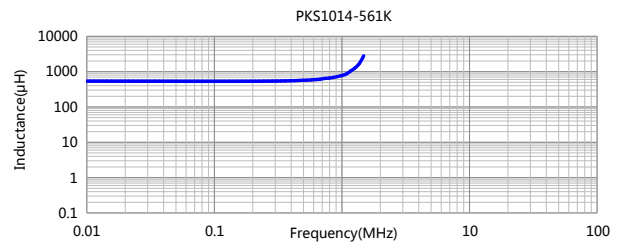
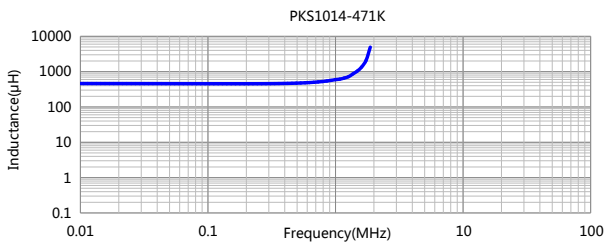
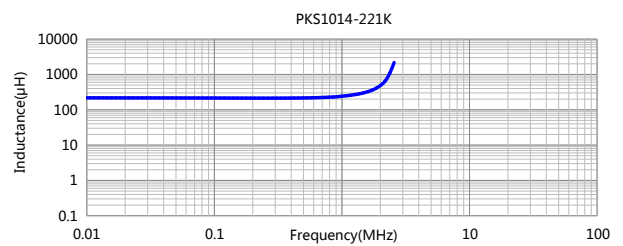
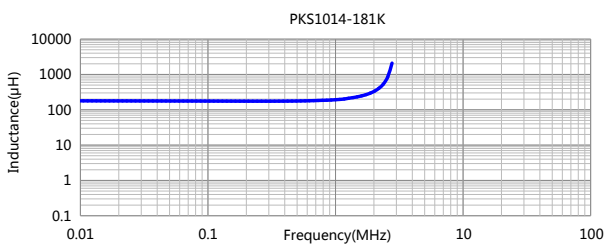
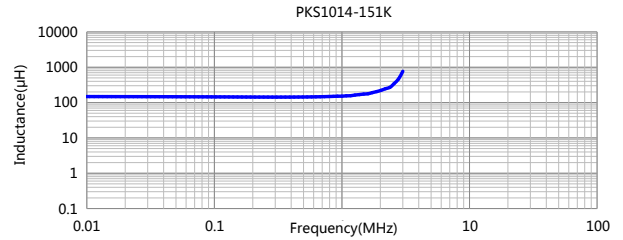
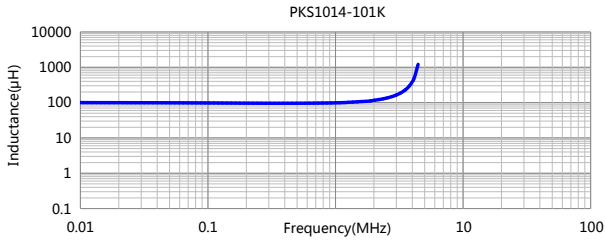

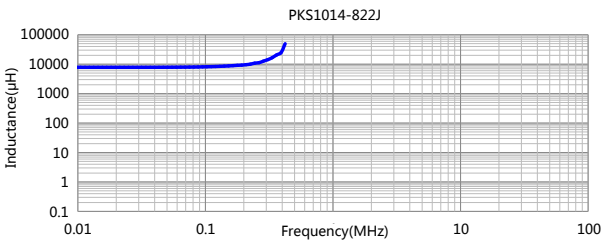
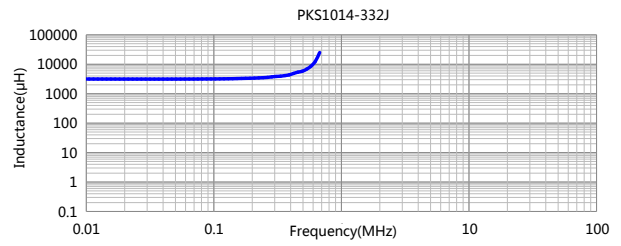
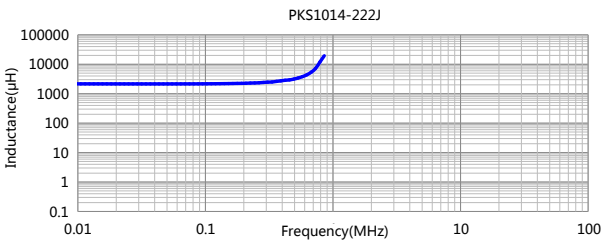

## 5 Impedance vs Frequency

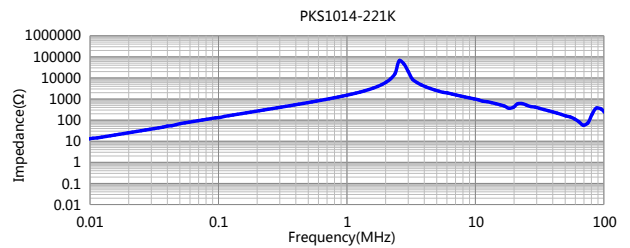
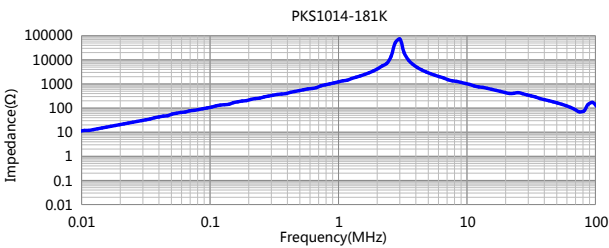
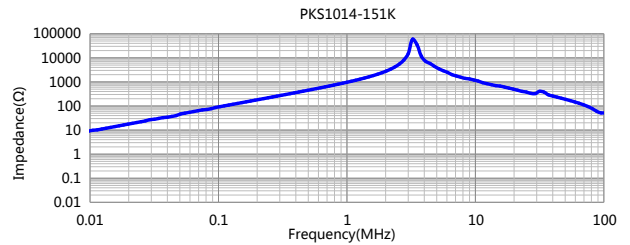
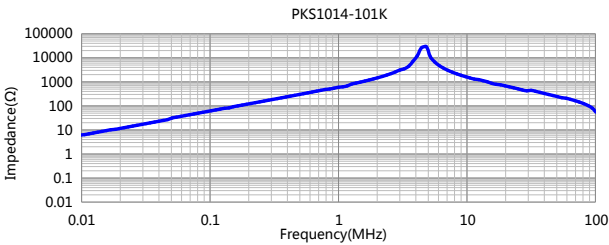

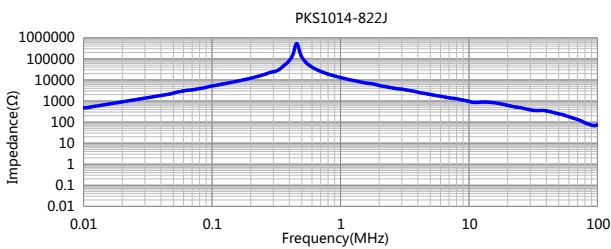
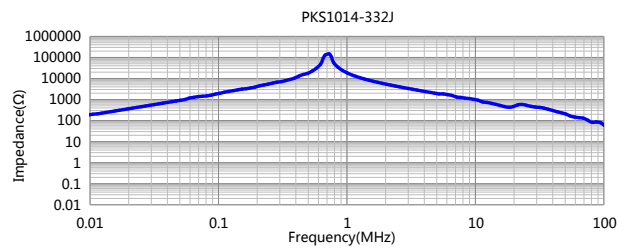
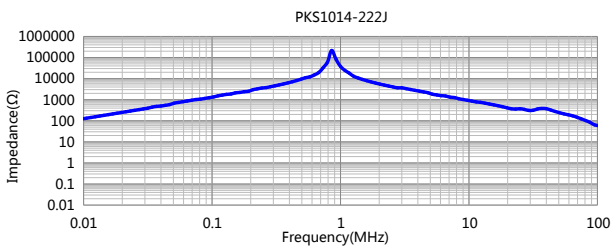
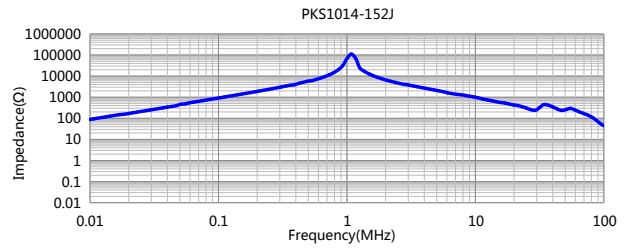
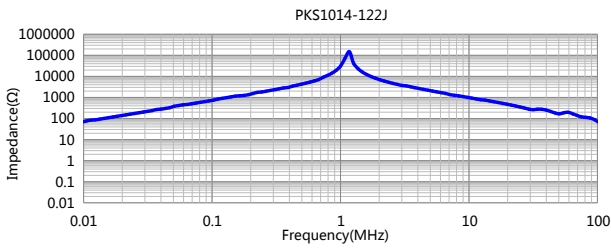
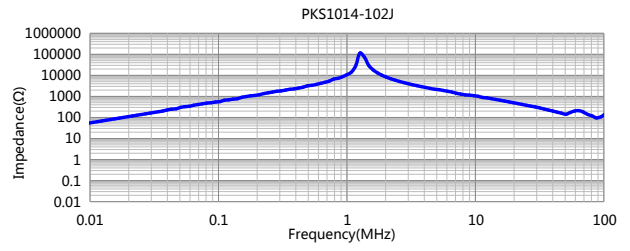
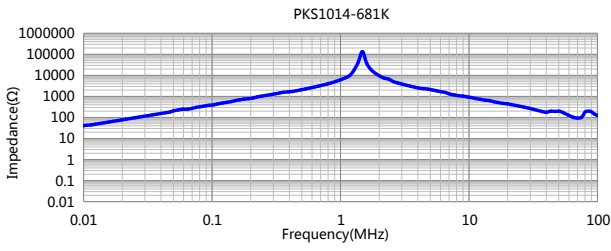
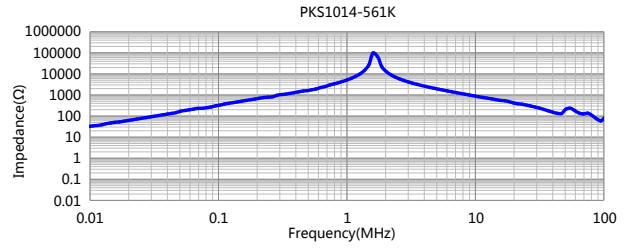
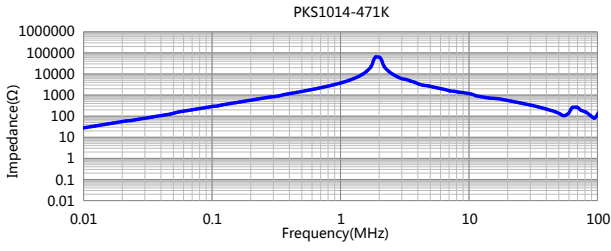

## 6 Packing Specification

### 6.1 Packing(mm)

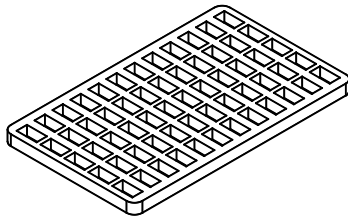

Tray × 17

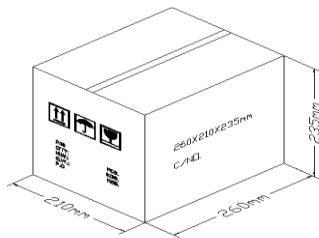
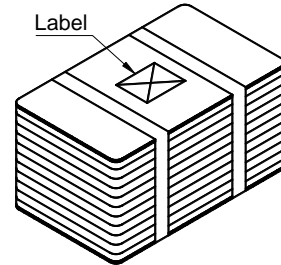
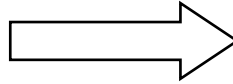

Bundle × 1

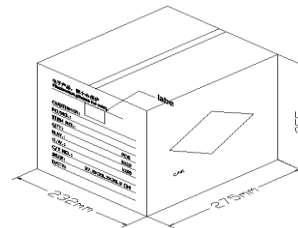
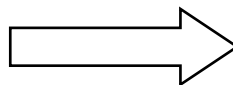

### 6.2 Carton Dimensions and Packing Quantity

■ Inner Carton: 260×210×235mm

■ Out Carton : 275×232×261mm

Product Series	Quantity / Tray	Inner Carton Quantity	Out Carton Quantity
PKS1014	80pcs	(80×17) = 1360pcs	(1360×1) = 1360pcs

### 6.3 Label Making

The following items will be marked on the tray of product label and shipping label.

Production Label
■ Packing No.
■ Quantity
■ Shipment Date
■ Part No.
■ Customer Part No.
■ Customer Po No.

Shipping Label
■ Packing No.
■ Quantity
■ Shipment Date
■ Part No.
■ Customer Part No.
■ Customer Po No.

**7 Notice of Use**

- 7.1 Special remind: Circuit design, component placement, PCB size and thickness, cooling system and etc. all will affect the product temperature. Please verify the product temperature in the final application.
- 7.2 Product in packing storage condition: temperature 5~40°C, RH≤70%.  
If taking out for use, the remaining products should be sealed in plastic bags and preserved in accordance with the above conditions, to avoid oxidation of terminals (electrodes), affecting soldering status.
- 7.3 A storage of Codaca Electronic products for longer than 12 months is not recommended, Within other effects, the terminals may suffer degradation, resulting in bad solderability. Therefore, all products shall be used within the period of 12 months based on the day of shipment.
- 7.4 Do not keep products in unsuitable storage conditions, such as areas susceptible to high temperatures, high humidity, dust or corrosion.
- 7.5 Always handle products with care.
- 7.6 Don't touch electrodes directly with bare hands as oil secretions may inhibit soldering.  
Always ensure optimum conditions for soldering.
- 7.7 When this product will be used on a similar or new project to the original one, sometimes it might be unable to satisfy the specifications due to different condition of usage.
- 7.8 This inductor itself does not have any protective function in abnormal condition, such as overload, short-circuit, open-circuit conditions, etc. Therefore, it shall be confirmed that there is no risk of smoke, fire, dielectric withstand voltage, insulation resistance, etc., or use in abnormal conditions protective devices or protection circuit in the end product.
- 7.9 Hi-Pot test with higher voltage than spec value will damage insulating material and shorten its life.
- 7.10 If using in potting compound, the magnet wire coating might be damaged, please consult with us.
- 7.11 Refrain from rinsing coils. If necessary, please consult with us.
- \* 7.12 Codaca Electronic products without "V" prefix are qualified for industrial product requirement, and with "V" prefix are qualified for AEC-Q200, but it doesn't mean that Codaca Electronic products can absolutely meet specific industry norms and quality test standards in automotive electronics or more strict application fields. Codaca Electronic will be exempted from being responsible for the consequences of using Codaca products in automotive electronic or higher application field related to safety when without being aware of it.