

### Outline:

- Excellent impedance characteristics, making it great for suppressing common mode noise.
- Highest possible rated current by small size.

### Features:

- Core material: Ferrite
- Environmental: RoHS, Reach compliant, Halogen free
- Weight: 12.5g
- Moisture Sensitivity: Level (MSL) 1 (unlimited floor life at <30°C / 85% relative humidity).
- Operating temperature range: -40°C ~ +105°C (including coil's self temperature rise)
- Storage temperature range: -40°C ~ +105°C

### Application:

- Measures against common mode noise in power lines for various DC power lines, multimedia devices, and various electronic devices, including automotive power trains.

## 1 Electrical Characteristics

Part No.	Inductance (mH) <sup>※1</sup>	D.C.R (mΩ)	Rated Current (A) <sup>※2</sup>	Rated Voltage (V)	Hi-pot (Vac)
	Min.	Max.	Max.	Max.	2mA 3S
CPSQ1515AS-502	5.00	80.0	4.50	250	1,500
CPSQ1515AS-103	10.0	130	2.40	250	1,500
CPSQ1515AS-153	15.0	130	2.70	250	1,500
CPSQ1515AS-203	20.0	150	2.70	250	1,500

### All data is tested on 25°C ambient temperature

1. Inductance measure condition at 1kHz, 0.25V.
2. Rated Current: the actual value of DC current when the temperature rise is  $\Delta T 40^{\circ}\text{C}$  ( $T_a = 25^{\circ}\text{C}$ )
3. Special remind: Circuit design, component placement, PCB size and thickness, cooling system and etc. all will affect the product temperature. Please verify the product temperature in the final application.

## 2 Product Dimensions(mm)

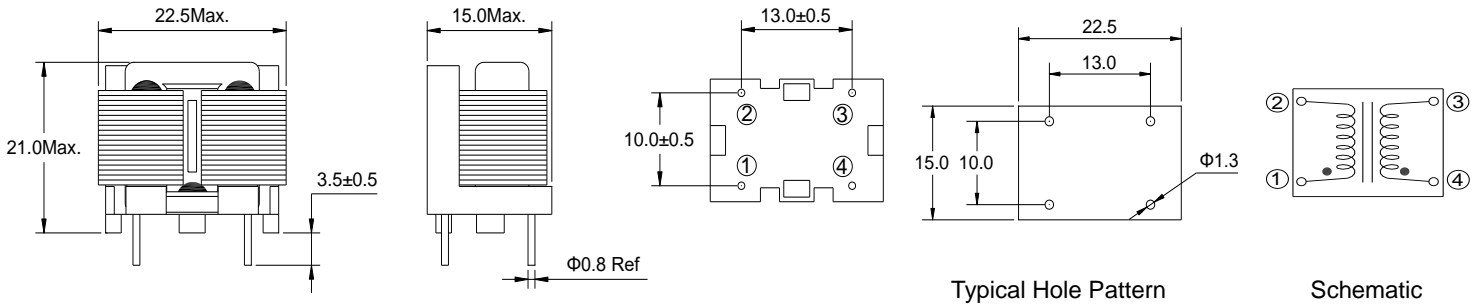

## 3 Impedance vs Frequency Curve

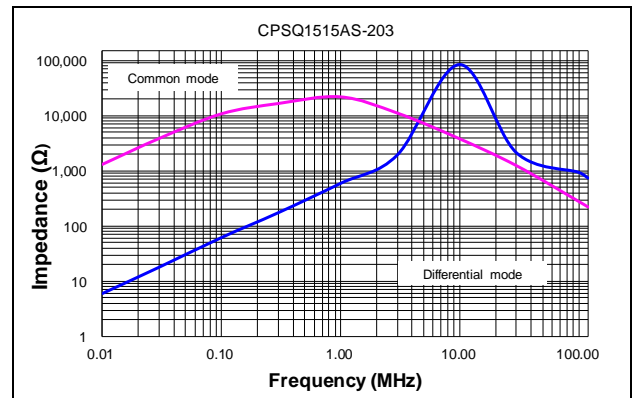
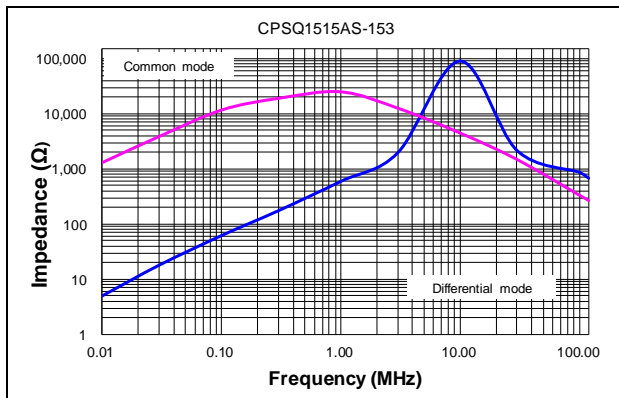
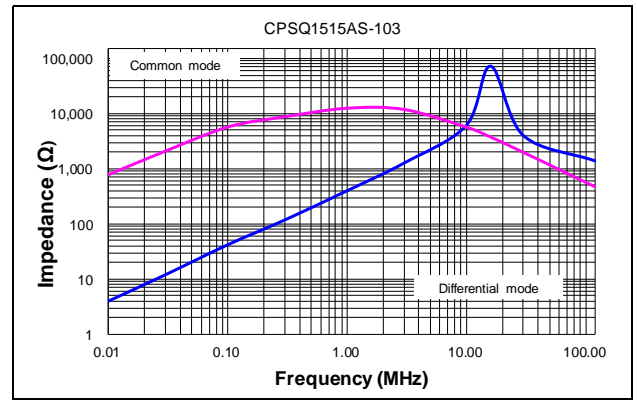
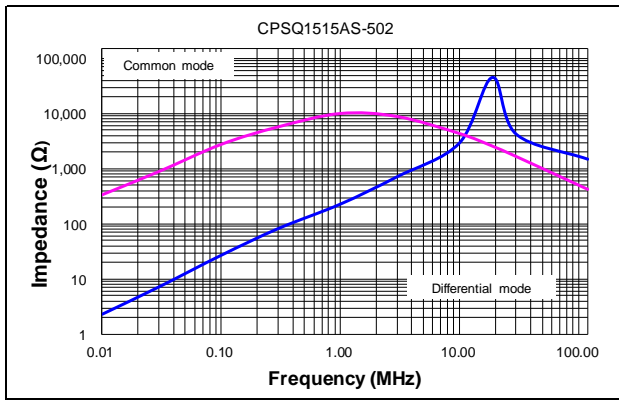

### 4 Packing Specification

#### 4.1 Plastic tray dimensions (mm)

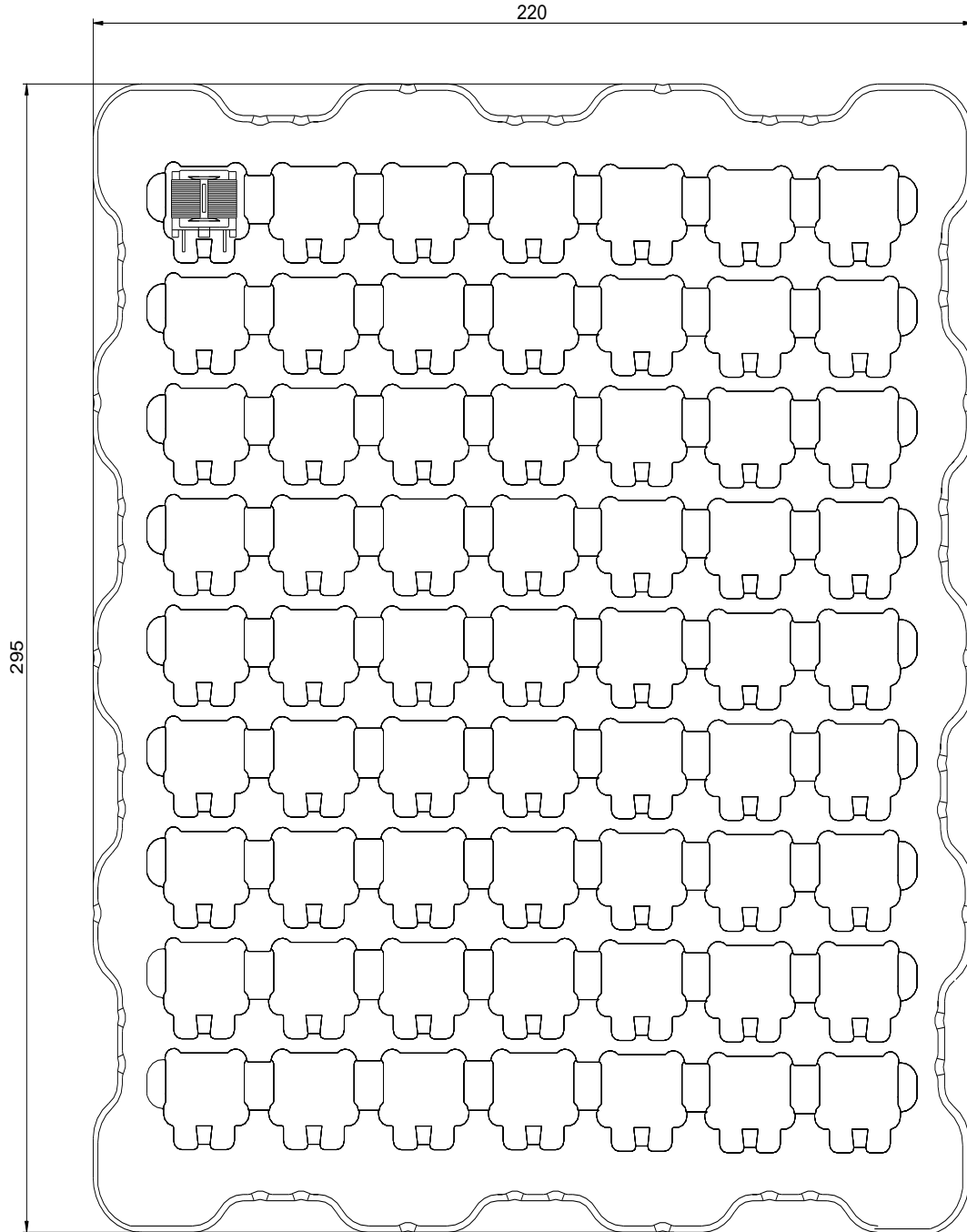

### 4.2 Packing

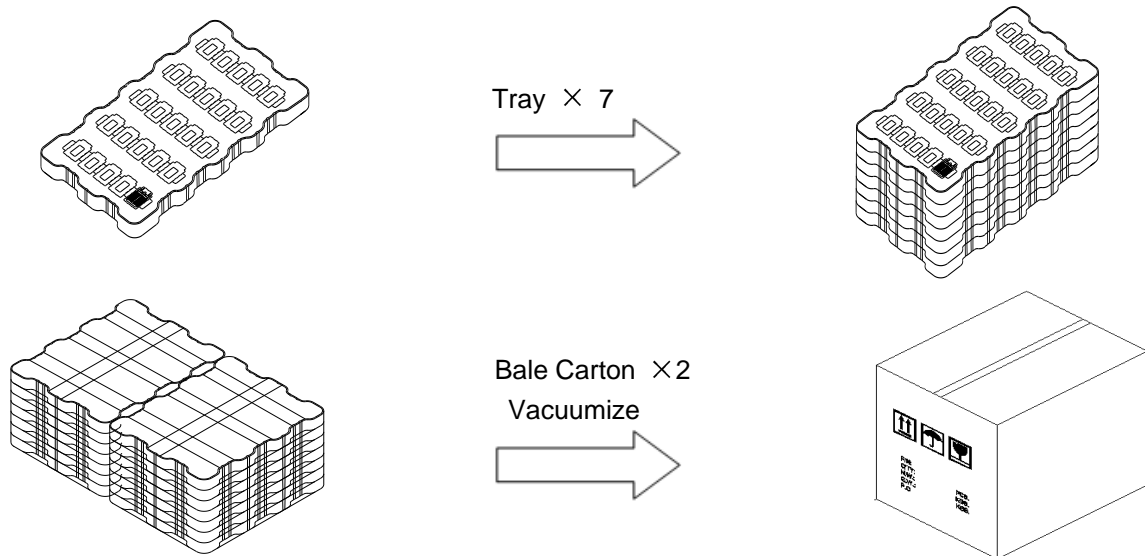

### 4.3 Carton dimensions and packing quantity

■ Inner Carton: 295×220×11mm

■ Out Carton : 315×240×220mm

Product Series	Quantity / Tray	Inner Carton Quantity	Out Carton Quantity
CPSQ1515AS	63pcs	(63×7) = 441pcs	(441×2) =882pcs

**5 Notice of Use**

- 5.1 Special remind: Circuit design, component placement, PCB size and thickness, cooling system and etc. all will affect the product temperature. Please verify the product temperature in the final application.
- 5.2 Product in packing storage condition: temperature 5~40°C, RH≤70%.  
If taking out for use, the remaining products should be sealed in plastic bags and preserved in accordance with the above conditions, to avoid oxidation of terminals (electrodes), affecting soldering status.
- 5.3 A storage of Codaca Electronic products for longer than 12 months is not recommended, Within other effects, the terminals may suffer degradation, resulting in bad solderability. Therefore, all products shall be used within the period of 12 months based on the day of shipment.
- 5.4 Do not keep products in unsuitable storage conditions, such as areas susceptible to high temperatures, high humidity, dust or corrosion.
- 5.5 Always handle products with care.
- 5.6 Don't touch electrodes directly with bare hands as oil secretions may inhibit soldering.  
Always ensure optimum conditions for soldering.
- 5.7 When this product will be used on a similar or new project to the original one,  
sometimes it might be unable to satisfy the specifications due to different condition of usage.
- 5.8 This inductor itself does not have any protective function in abnormal condition, such as overload, short-circuit, open-circuit conditions, etc. Therefore, it shall be confirmed that there is no risk of smoke, fire, dielectric withstand voltage, insulation resistance, etc., or use in abnormal conditions protective devices or protection circuit in the end product.
- 5.9 Hi-Pot test with higher voltage than spec value will damage insulating material and shorten its life.
- 5.10 If using in potting compound, the magnet wire coating might be damaged, please consult with us.
- 5.11 Refrain from rinsing coils. If necessary, please consult with us.
- \* 5.12 Codaca Electronic products without "V" prefix are qualified for industrial product requirement , and with "V" prefix are qualified for AEC-Q200, but it doesn't mean that Codaca Electronic products can absolutely meet specific industry norms and quality test standards in automotive electronics or more strict application fields . Codaca Electronic will be exempted from being responsible for the consequences of using Codaca products in automotive electronic or higher application field related to safety when without being aware of it.